

# RADIO FLYER

## "LIBERTY" The Spring Horse™

### model/modèle/modelo #301 r.3

Patents Pending / Brevets en attente / Patente pendiente

For ages 2 to 6 years. Max weight 60 lbs.

Pour enfants de 2 à 6 ans. Charge maximale 60 livres (27 kg).

Para los niños 2 a 6 años. Peso máximo 60lbs (27kg).

Thank you for your purchase. If you have any questions or comments, please visit the customer service section of our website:

Merci d'avoir acheté notre produit. Si vous avez des questions ou commentaires, veuillez référer notre site web dans la section de service à la client le.

Gracias por su compra. Si tiene preguntas o comentarios por favor visite la seccion, servicio al cliente de nuestro website:

# www.radioflyer.com

Or phone / ou composez le / o llame al 1-800-621-7613

Available weekdays 8:00 a.m. to 5:00 p.m. CST.  
Disponible sur semaine de 8:00 heures 17:00 heures.  
Lunes a viernes de 8:00 a.m. a 5:00 p.m. CST.

Radio Flyer Inc. / 6515 West Grand Ave. / Chicago, IL 60707  
phone: 773-637-7100 fax: 773-637-8874

*The Original Little Red Wagon® - Since 1917*

# 1

Tools Required:  
Outils nécessaires:  
Herramientas necesarias:

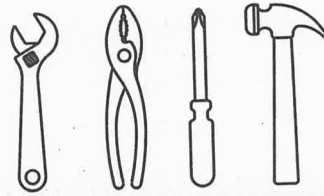

Tools Included:  
Outils fournis:  
Herramientas incluidas:

300.0922399 (x1)

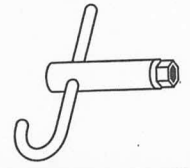

# 2

Hand Grip  
Poignées  
Manija



Handle Bar  
Barre  
Manubrio

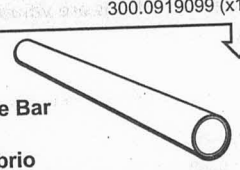

Spacer  
Cale  
Espaciador

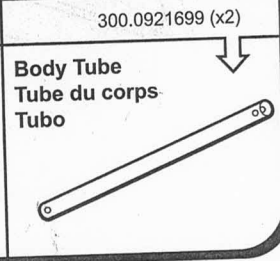
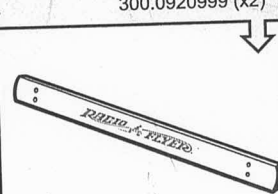
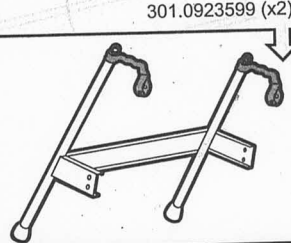
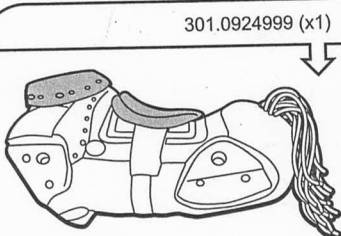
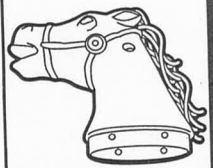

# 3

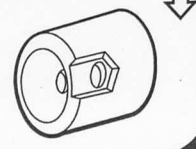
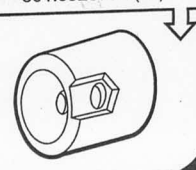
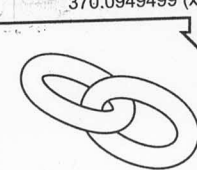
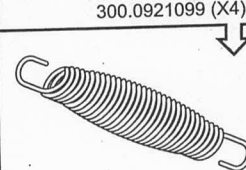
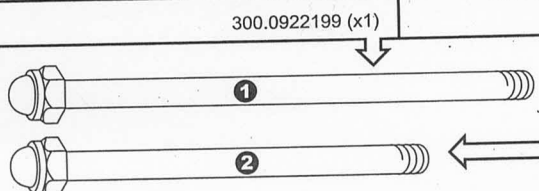
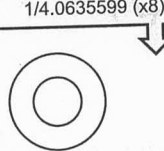
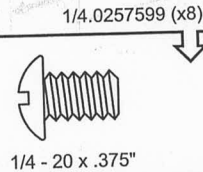
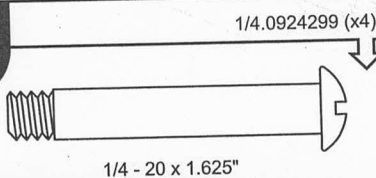

**4****⚠ CAUTION:****ADULT ASSEMBLY REQUIRED.**

This package contains small parts which, before assembly, present a choking hazard to children under the age of three. Care should be taken during unpacking and assembly to insure that all small parts and plastic bags are accounted for and kept out of the reach of children.

**⚠ ATTENTION:****ASSEMBLAGE REQUIS PAR ADULTE.**

Cet emballage contient de petites pièces qui, avant l'assemblage, présentent un danger potentiel de suffocation avec les enfants âgés de moins de trois ans. Prendre les précautions nécessaires au cours du déballage et de l'assemblage afin de garantir que toutes les pièces et plastique sacs ont été incluses et tenues à l'écart des enfants.

**⚠ PRECAUCIÓN:****MONTAJE REQUERIDO POR ADULTOS.**

Este paquete contiene pequeñas piezas que, antes del montaje, presentan un peligro potencial de asfixia para niños de menos de tres años de edad. Se debe tener todas las piezas pequeñas y plástico bolsos y ponerlas fuera del alcance de los niños.

These instructions are valuable. It will assure your being able to obtain proper parts service at all times. We suggest you keep it with other valuable papers. Ces instructions sont importantes. Elles vous permettront d'obtenir des pièces de rechange quand vous en aurez besoin. Nous vous suggérons de les conserver en lieu sûr. Estas instrucciones son muy útiles. Le permitirán obtener piezas de repuesto en el futuro. Le sugerimos que las guarde junto con sus papeles importantes.

**5**

- Assemble frame sides and rails.
- Assemblez les parties latérales et les rails.
- Lados y rieles del cuadro de soporte.

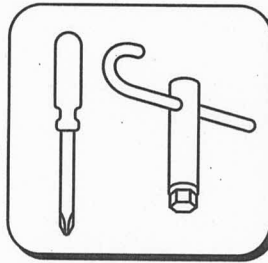

**Step 5 Bag**  
Sac de l'étape 5  
Paso 5 Bolsa

1/4 - 20 x .375"  
1/4.0257599 (x8)

1/4.0517999 (x8)

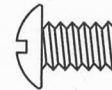

1/4 - 20

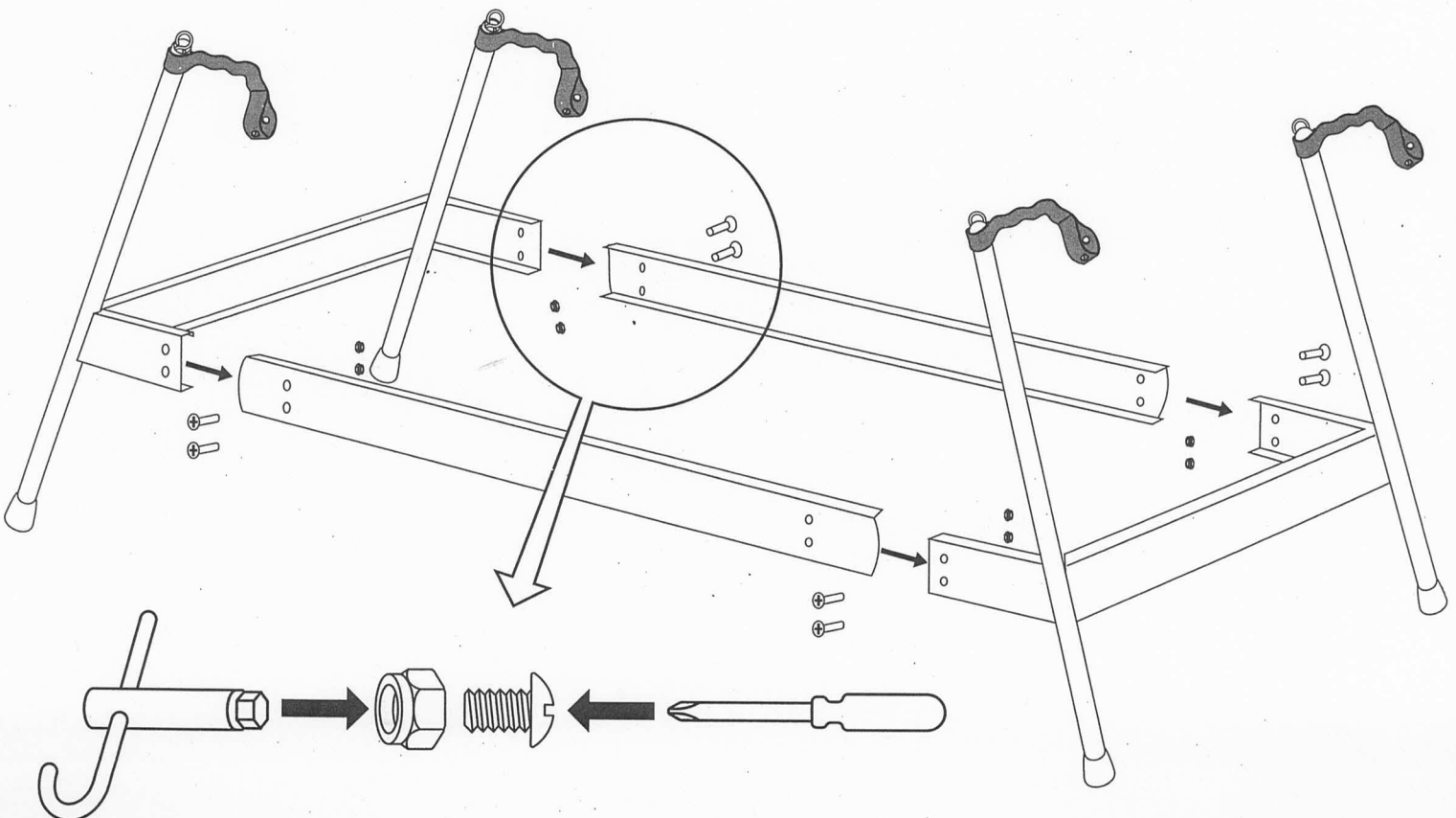

**6**

- Slide fabric spring covers over frame.
- Faites glisser les gaines des ressorts sur le cadre.
- Deslice las cubiertas de los resortes sobre el marco.

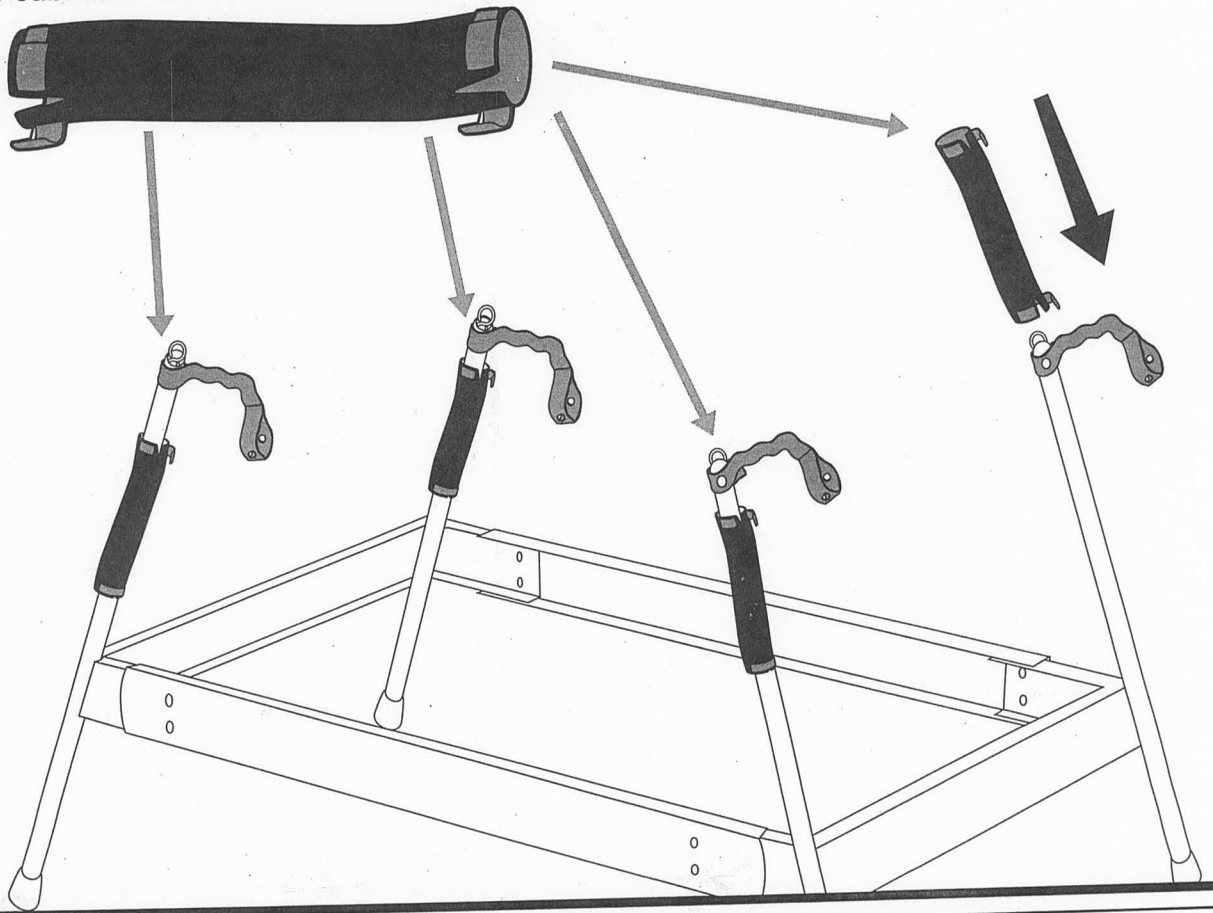
**7**

- Slide leg tubes through body.
- Faites glisser les tubes des jambes et du guidon à travers le corps de l'animal.
- Deslice los tubos para las piernas a través del cuerpo.

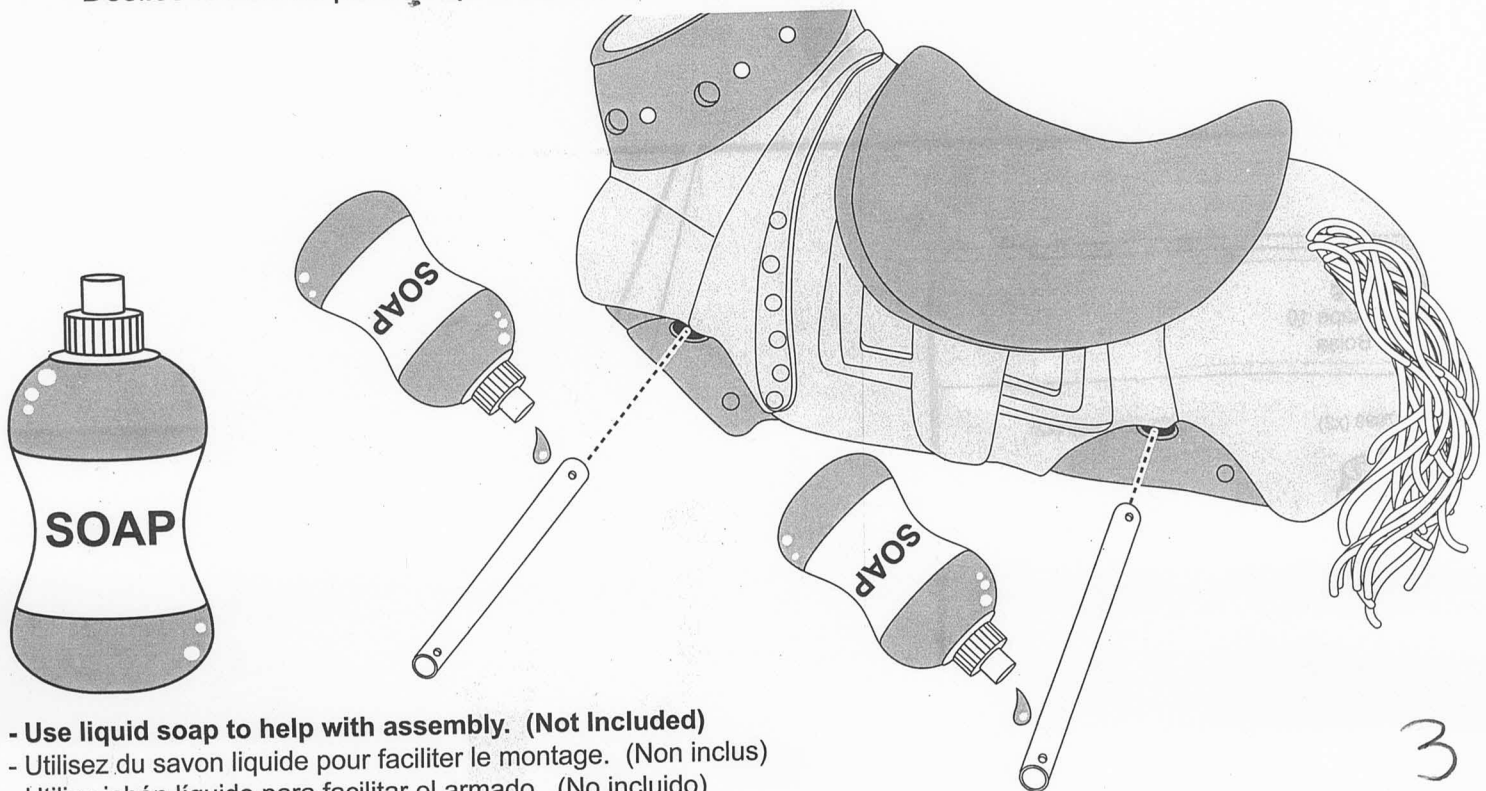

- Use liquid soap to help with assembly. (Not Included)
- Utilisez du savon liquide pour faciliter le montage. (Non inclus)
- Utilice jabón líquido para facilitar el armado. (No incluido)

8

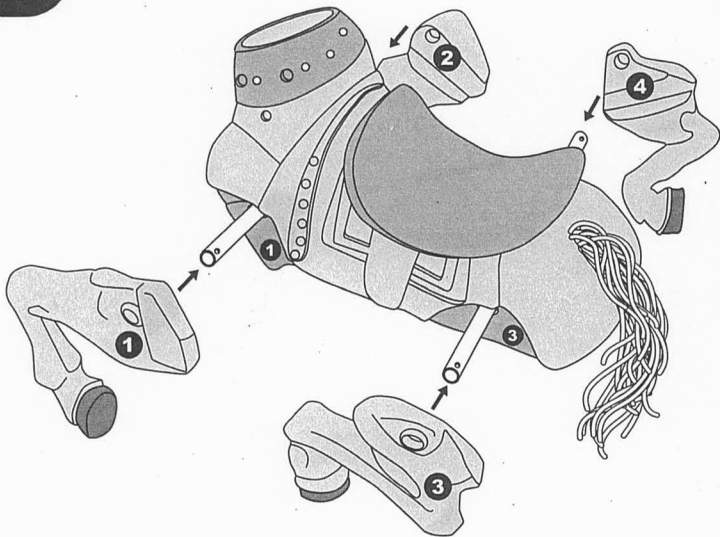

- Slide spacers onto rear leg tubes.
- Faites glisser les cales sur les tubes des jambes arrière.
- Deslice los espaciadores en los tubos de las patas traseras.

9

- Slide legs onto leg tubes.
- Faites glisser les pieds sur les tubes des pieds.
- Deslice las patas en los tubos para las piernas.

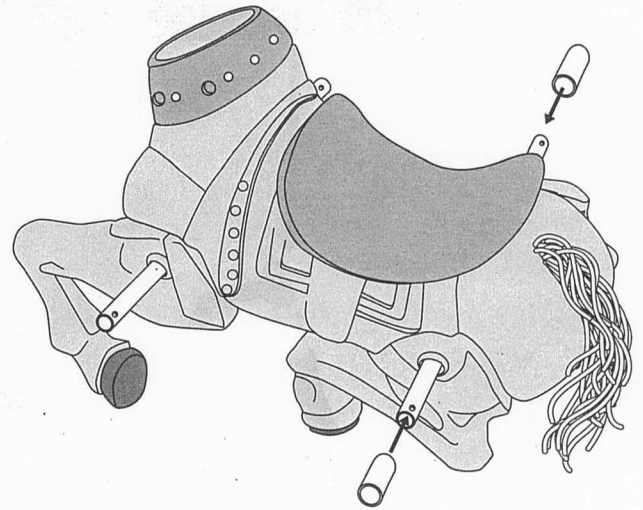

10

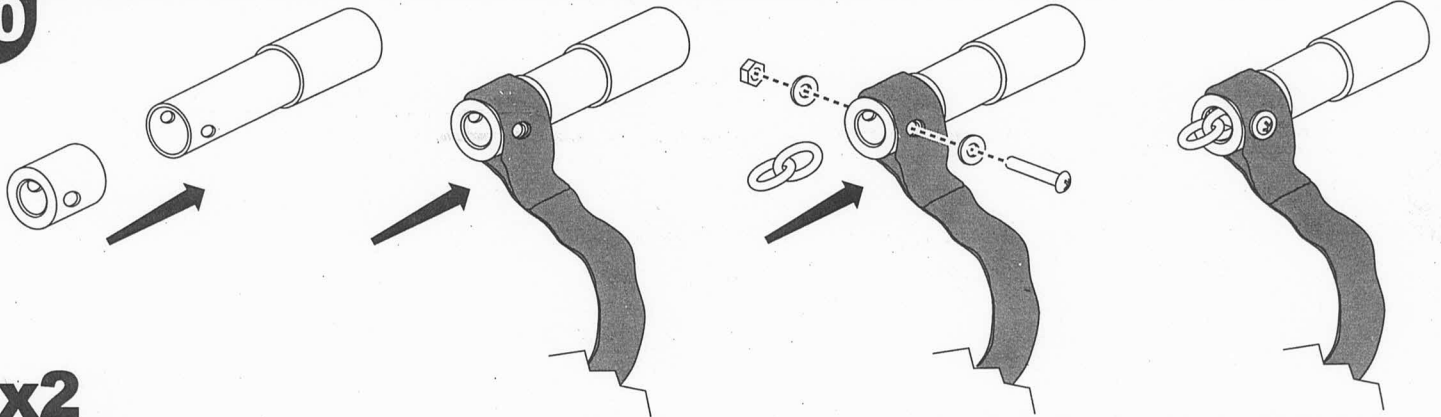

x2

**Step 10 Bag**  
 Sac de l'étape 10  
 Paso 10 Bolsa

1/4 .0517999 (x2)



1/4 - 20

370.0949499 (x2)



1/4.0635599 (x4)

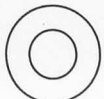

1/4 - 20 x 1.625"  
1/4.0924299 (x2)

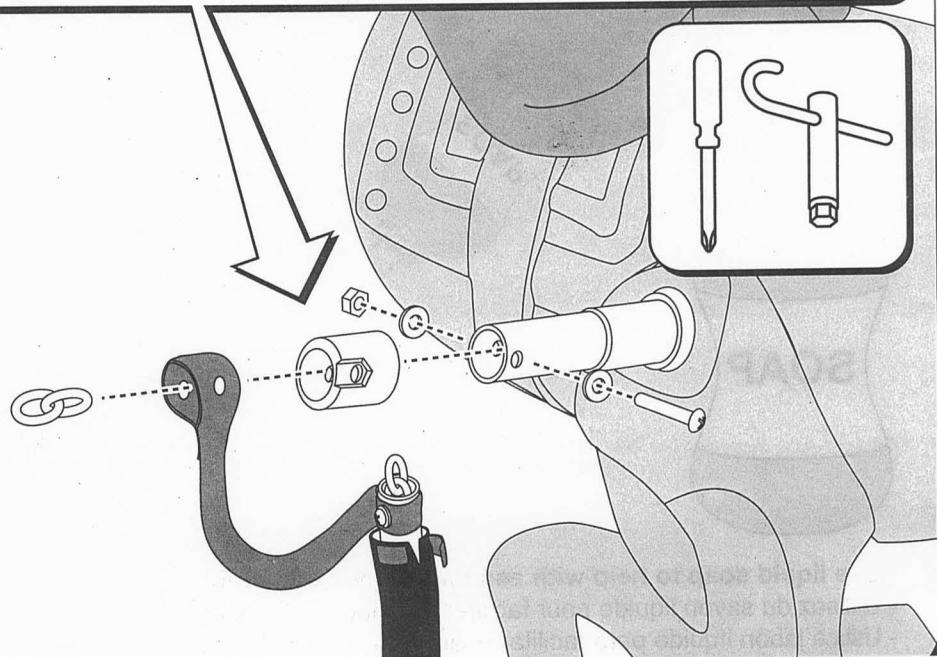
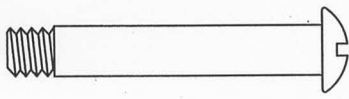

11

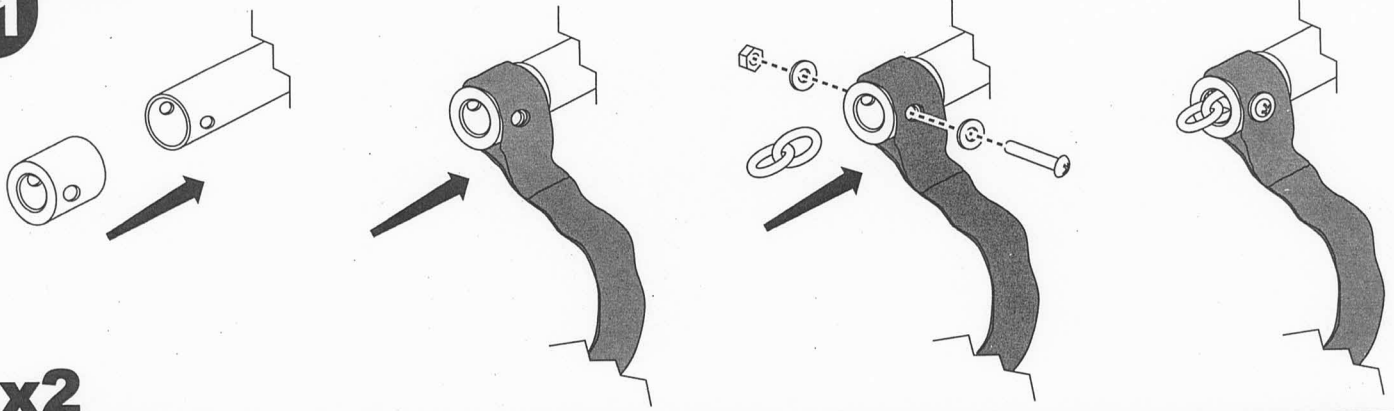

x2

Step 11 Bag  
 Sac de l'étape 11  
 Paso 11 Bolsa

1/4 .0517999 (x2)



1/4 - 20

370.0949499 (x2)

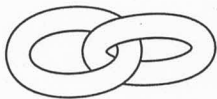

1/4.0635599 (x4)



1/4 - 20 x 1.625"  
1/4.0924299 (x2)

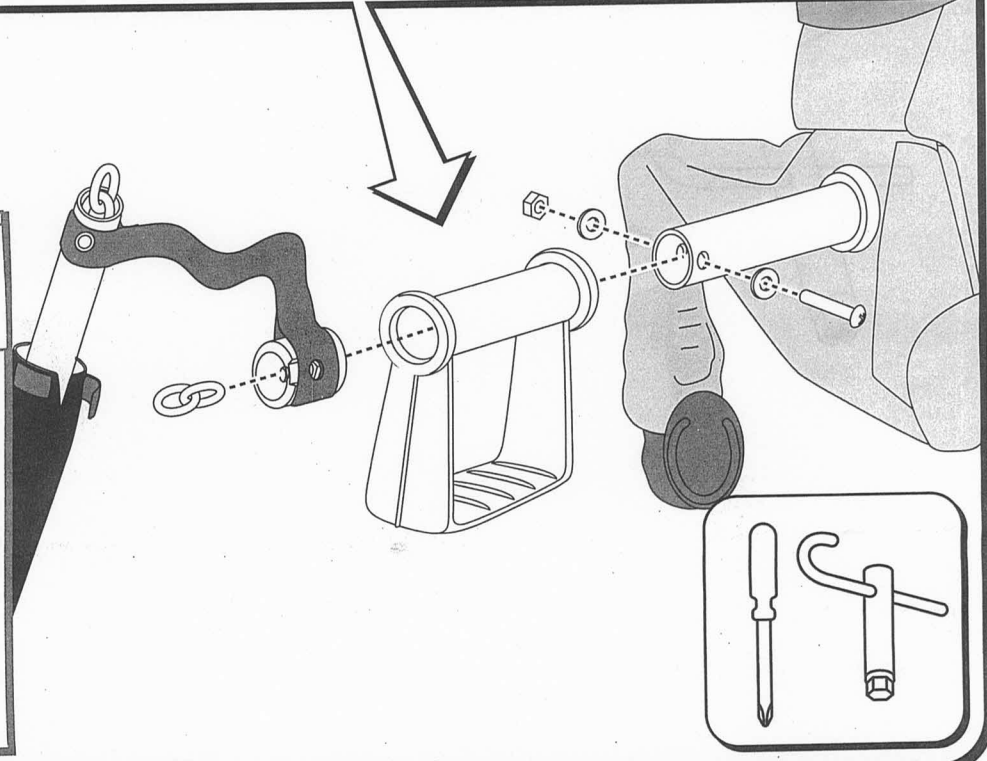
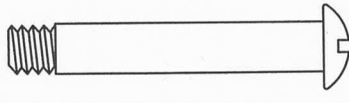

12

300.0924499 (x4)

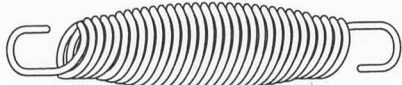

x4

